

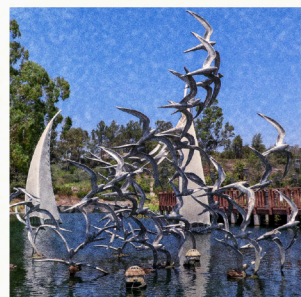

City of SANTA CLARITA

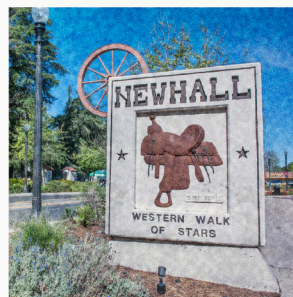
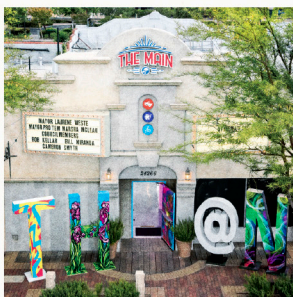
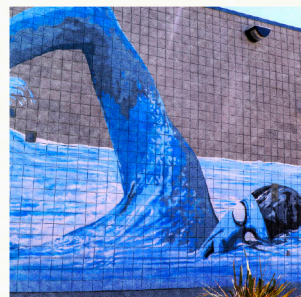
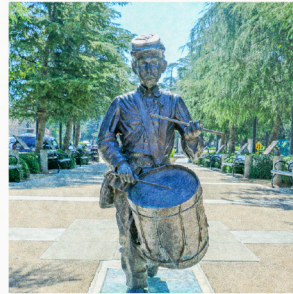
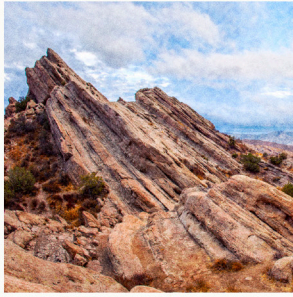

The History of Santa Clarita

COLORING
BOOK 2018



STATE OF THE CITY LUNCHEON 2018

Mayor Laurene Weste, Mayor Pro Tem Marsha McLean,
Councilmembers Bob Kellar, Bill Miranda and Cameron Smyth

City Manager Ken Striplin

Illustrations: Frank and Carol Rock
Puzzles: Patti Rasmussen
Historian: Leon Worden

TATAVIAM DWELLING

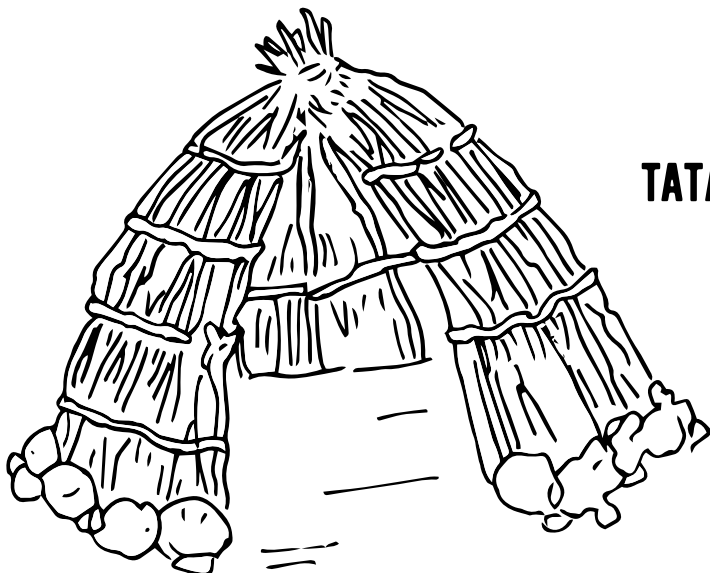

**TRAIL MARKER TREE
PICO CANYON**

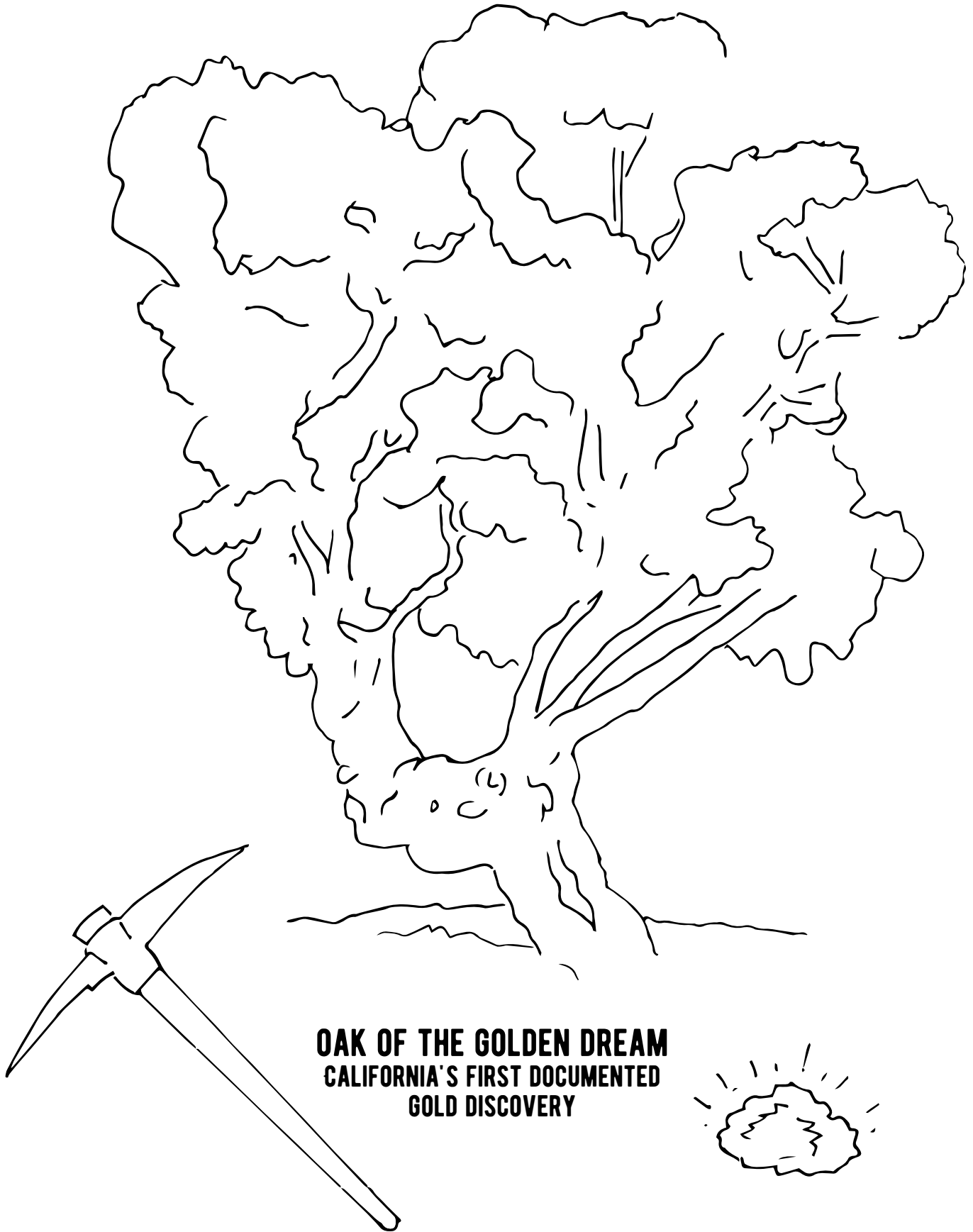

**OAK OF THE GOLDEN DREAM
CALIFORNIA'S FIRST DOCUMENTED
GOLD DISCOVERY**



TIBURCIO VASQUEZ

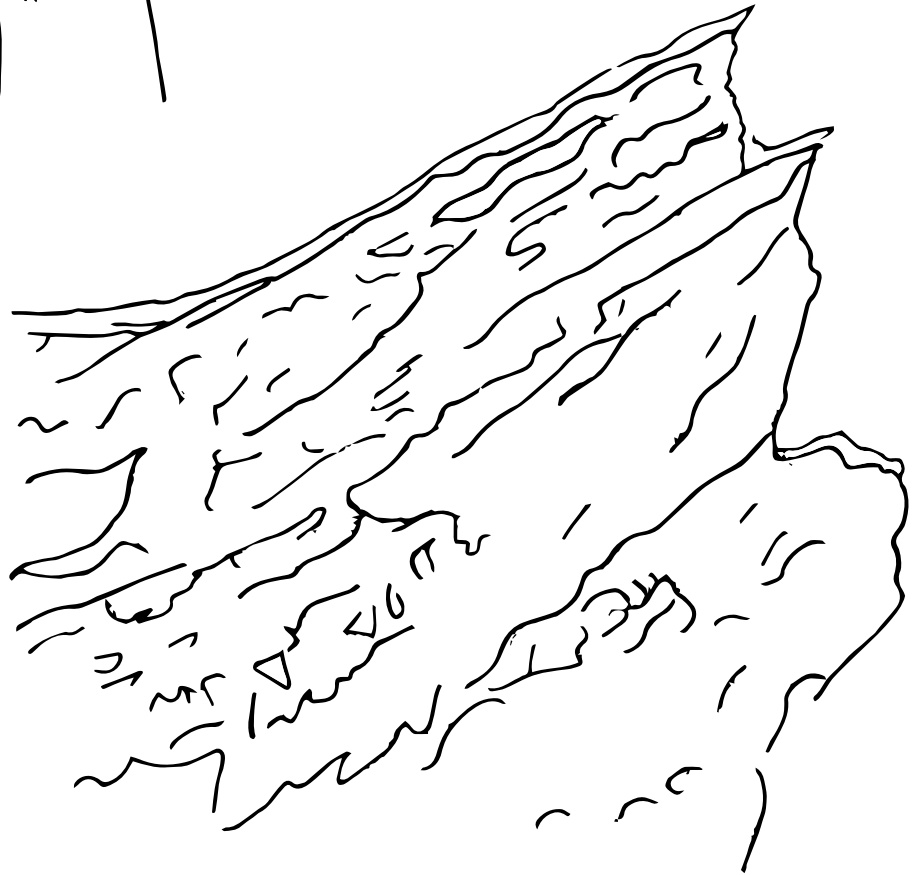

VASQUEZ ROCKS

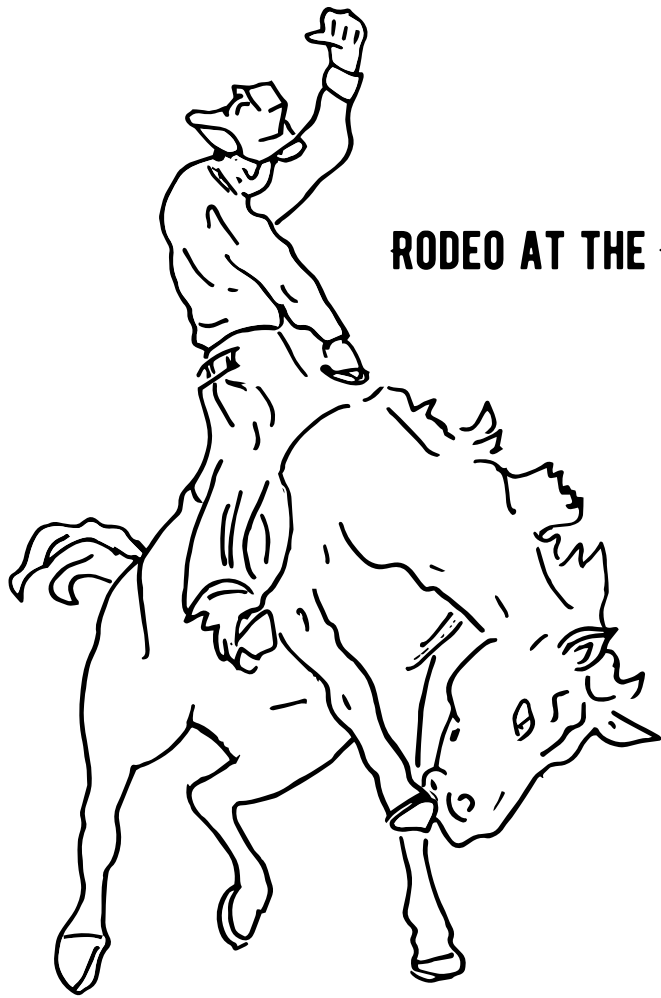

RODEO AT THE HOOT GIBSON ARENA

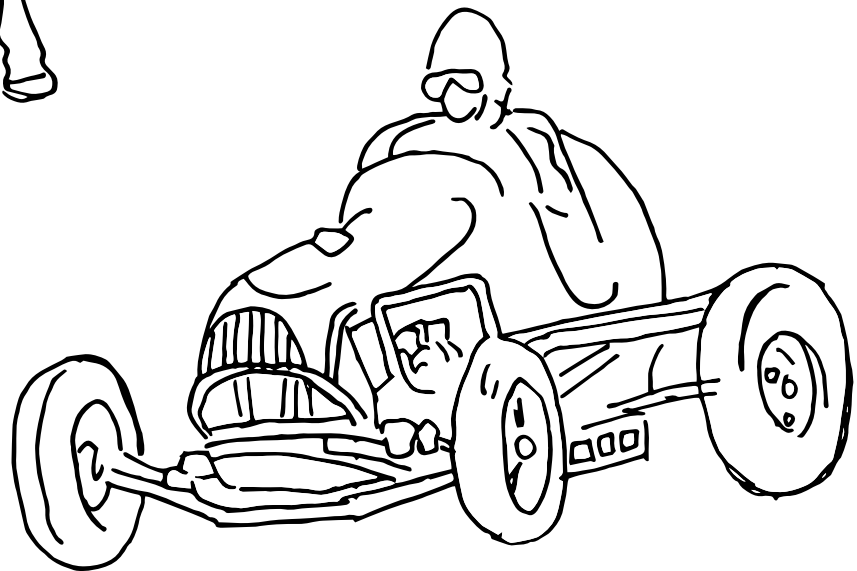

AUTO RACING AT BONELLI STADIUM/SAUGUS SPEEDWAY

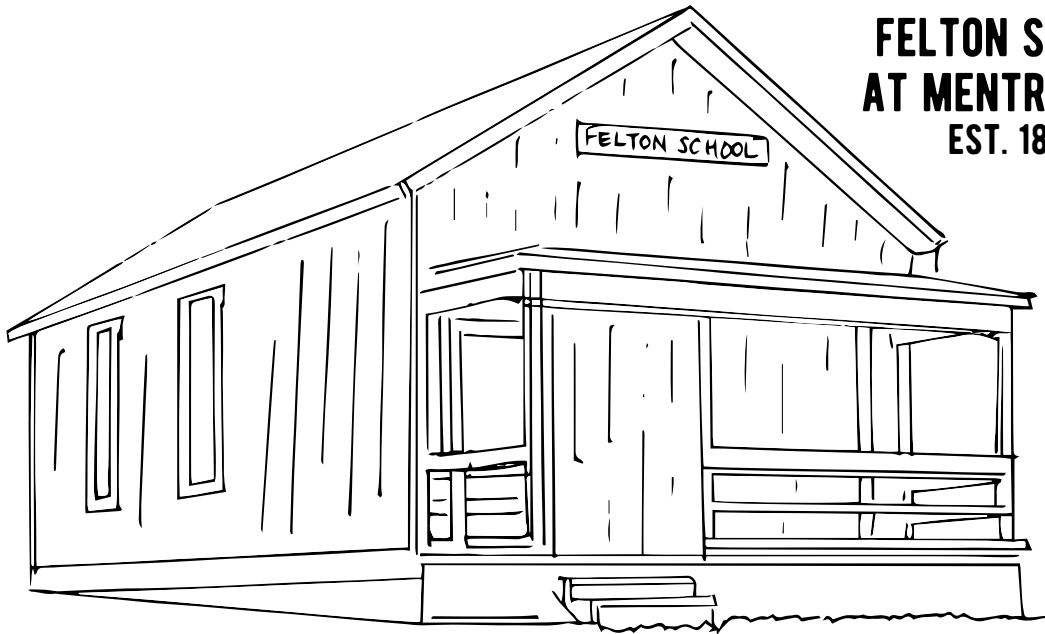

**FELTON SCHOOL
AT MENTRYVILLE
EST. 1885**



CHARLES ALEXANDER MENTRY'S HOME IN MENTRYVILLE

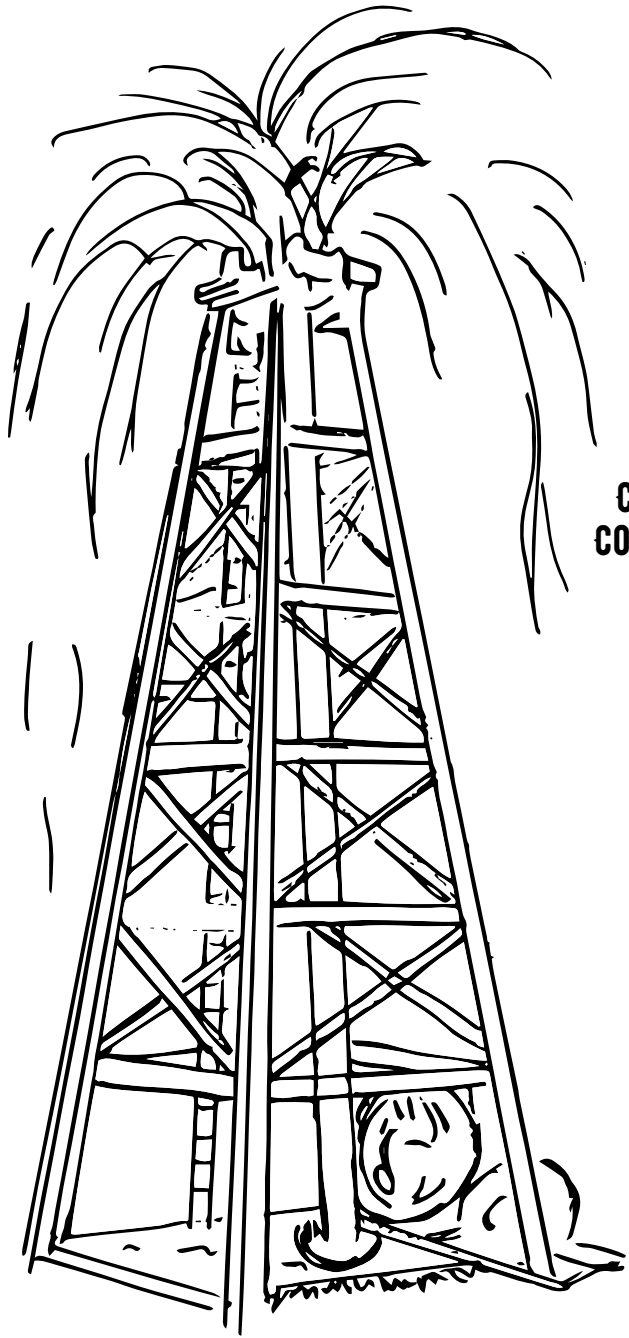

**PICO NO. 4
CALIFORNIA'S FIRST
COMMERCIAL OIL WELL
MENTRYVILLE**

**PIONEER OIL
REFINERY
NEWHALL**

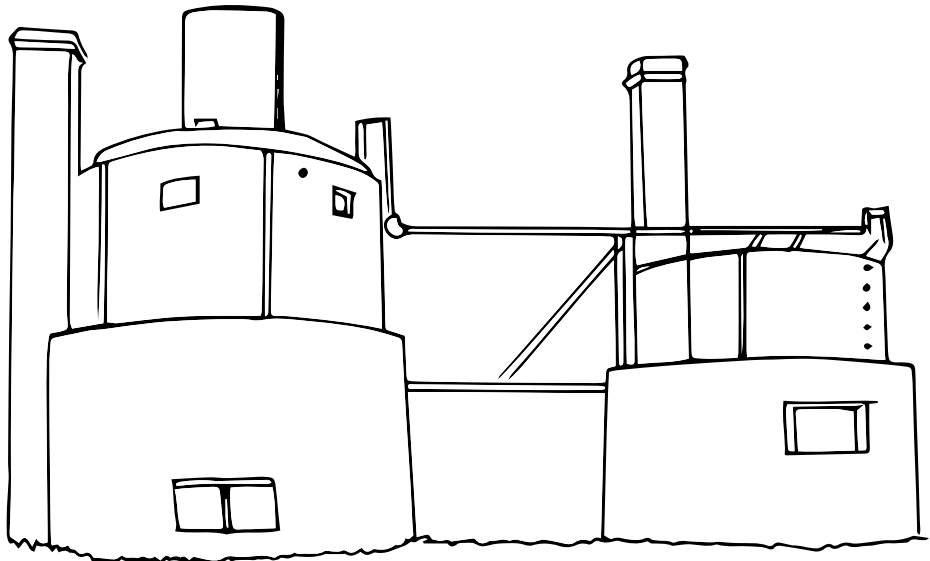

BEALE'S CUT 1860S

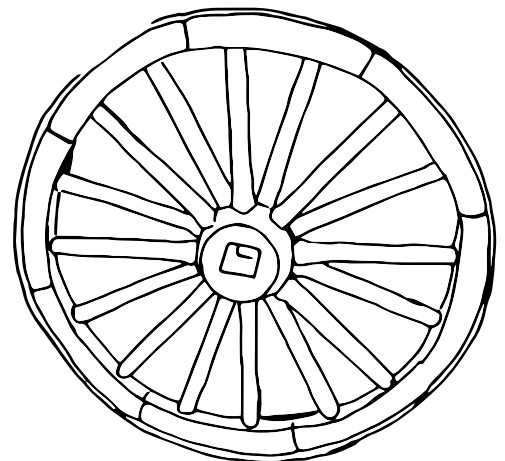
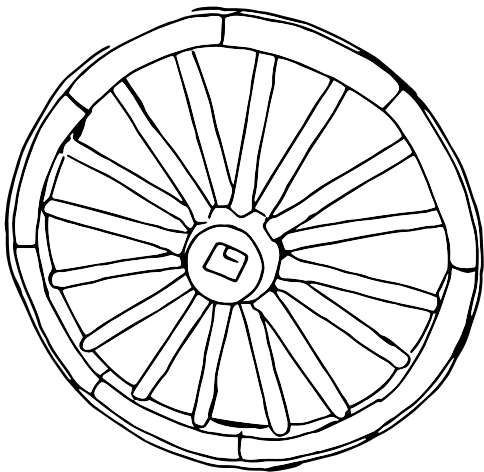
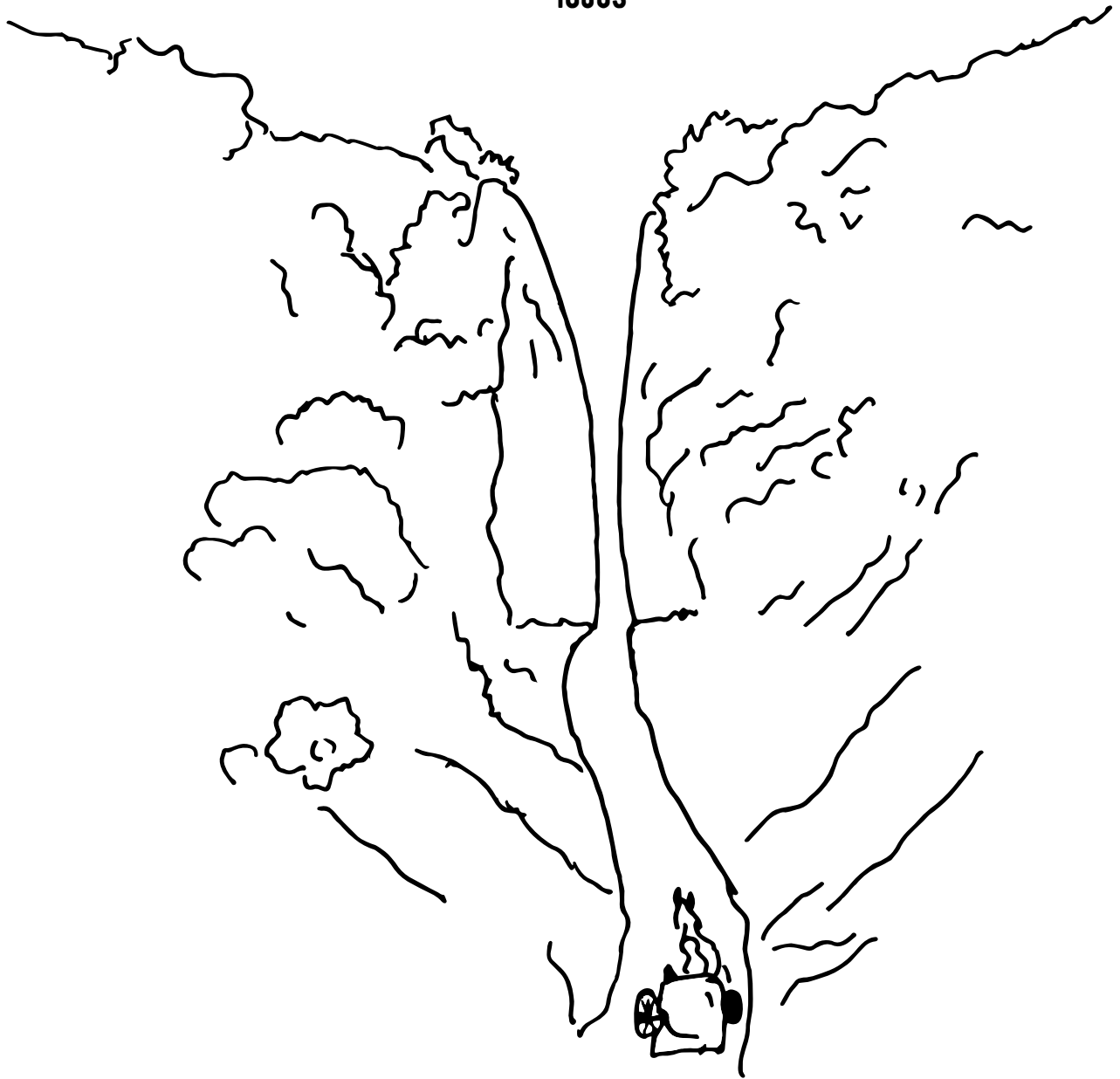

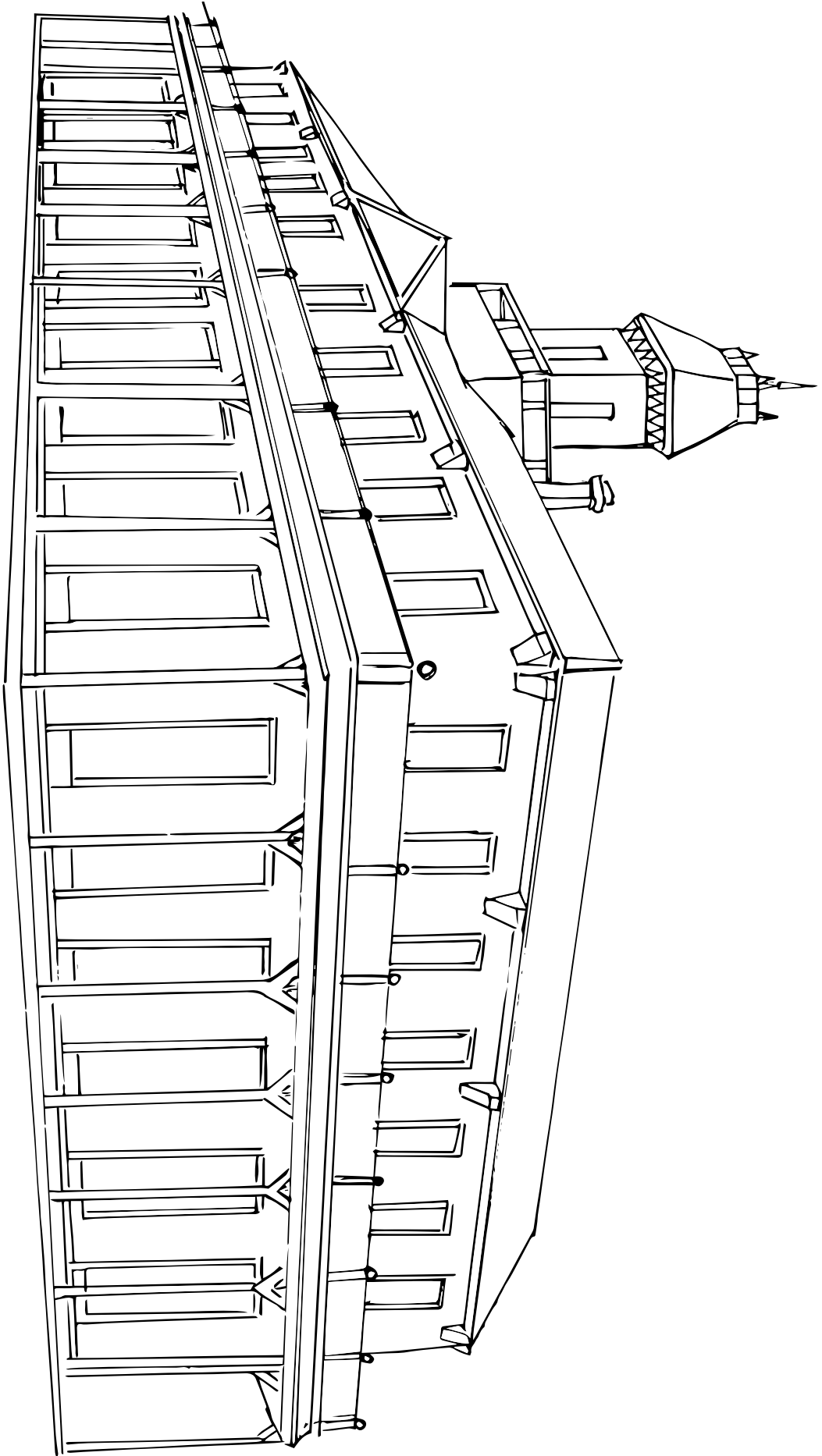

SOUTHERN HOTEL
CORNER OF MARKET STREET
AND RAILROAD AVENUE

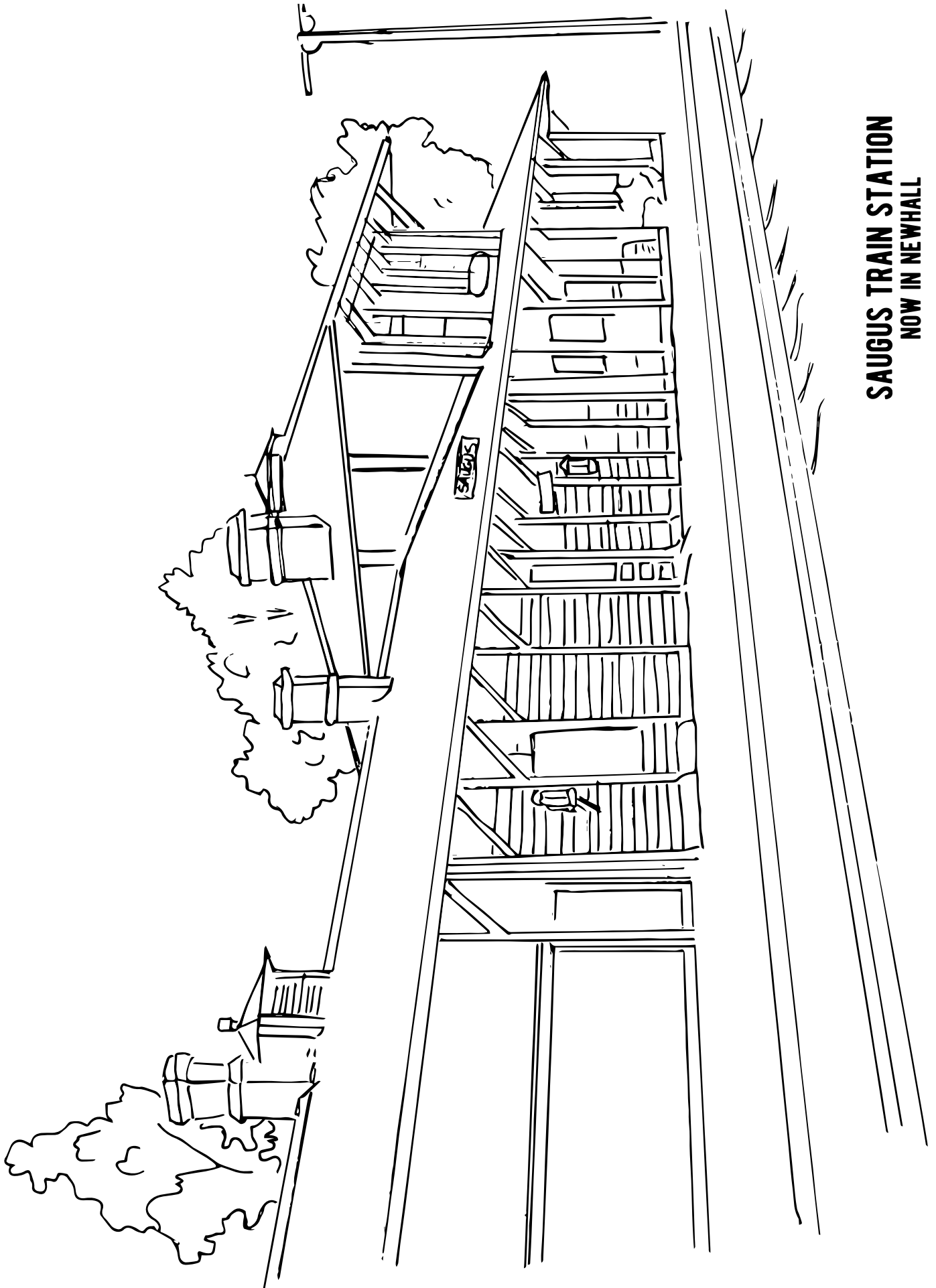

**SAUGUS TRAIN STATION
NOW IN NEWHALL**

**QUESTERS COURT
HERITAGE JUNCTION**



KINGSBURY HOUSE

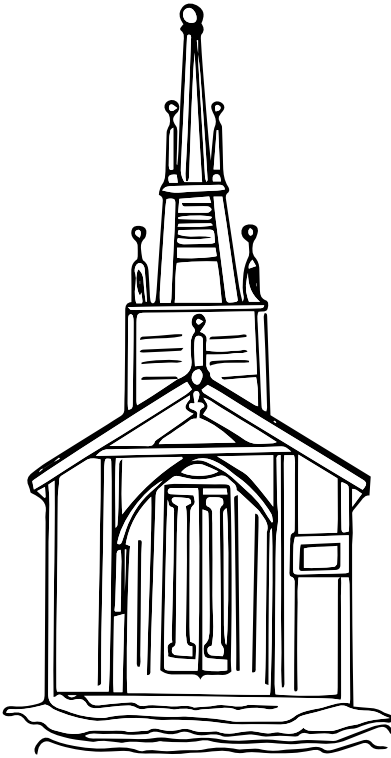

RAMONA CHAPEL



EDISON HOUSE

ST. FRANCIS DAM
1926-1928

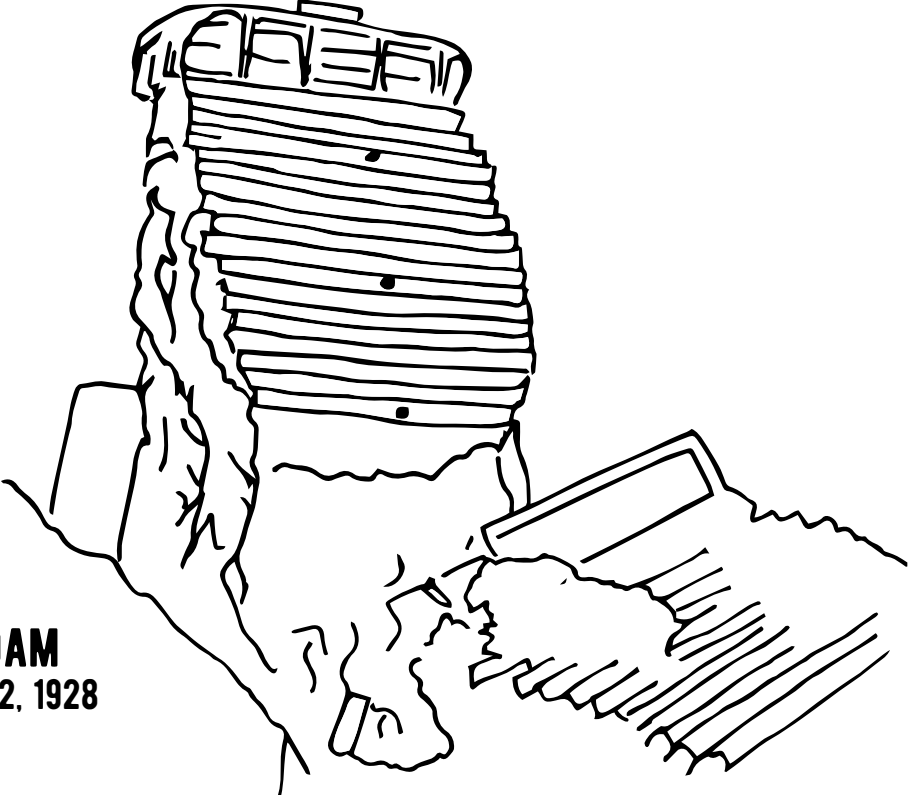
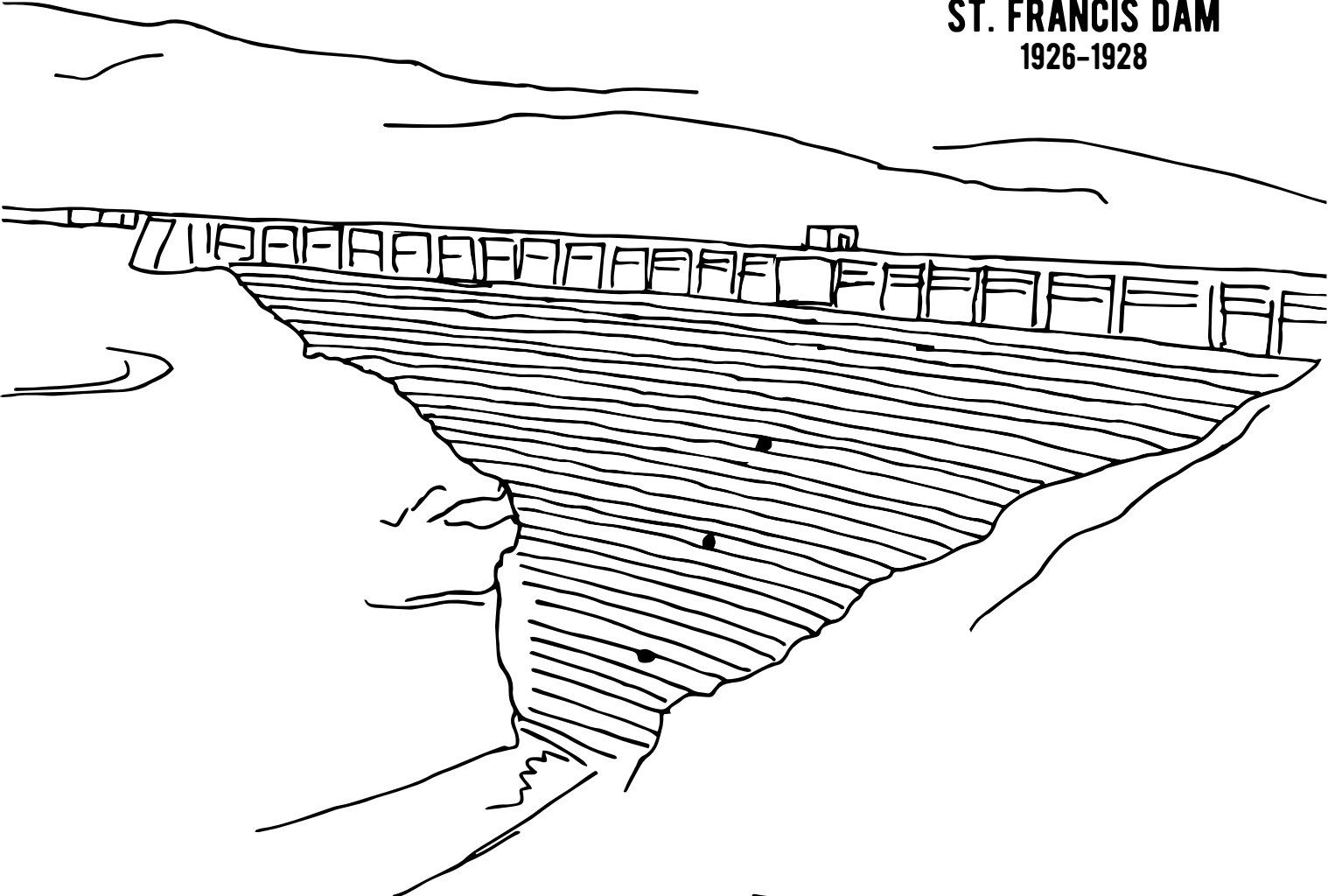

ST. FRANCIS DAM
COLLAPSED MARCH 12, 1928

CROSSWORD PUZZLE

Can you solve the mystery?!?!

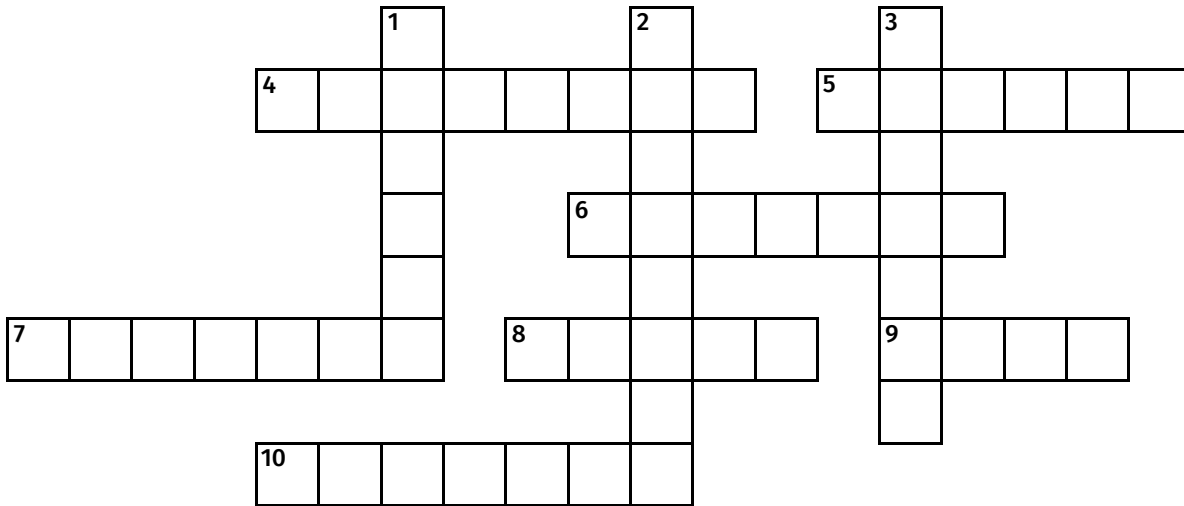

ACROSS

4. Car races were held at the Saugus _____.
5. Gold discovered at Oak of the _____ Dream
6. Bandit Tiburcio hid out at _____ Rocks.
7. Broke in 1928 - St. _____ Dam.
8. Bill Hart's horse's name
9. Golden spike hammered here bringing east/west tracks together at _____ Station.
10. Silent movie star _____ S. Hart

DOWN

1. Stagecoach mountain pass to Los Angeles: _____ Cut.
2. SCV Native American Tribe
3. Rodeos before car racing held here at _____ Stadium

MATCH GAME

Match each art piece with its location!



1. History Bear



3. Crossroads



5. Friends



7. Archways



9. Western Walk of Stars saddles



2. Amgen Bicycle Bear



4. Art Tree Mural



6. Willie Johnston



8. Western Tiger Swallowtail

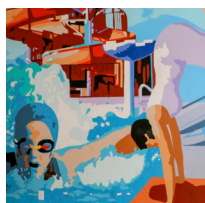

10. Together in Fun and Fitness

A. McBean Transit Center

B. South Fork Trail

C. Newhall Community Center

D. Old Town Newhall Library

E. Bridge at Magic Mtn. Parkway

F. Chuck Pontius Commuter-Rail Trail

G. Old Town Newhall Library

H. Veterans Historical Plaza

I. Central Park

J. Canyon Country Park

IRON HORSE TRESTLE



MOGUL ENGINE 1629
HERITAGE JUNCTION

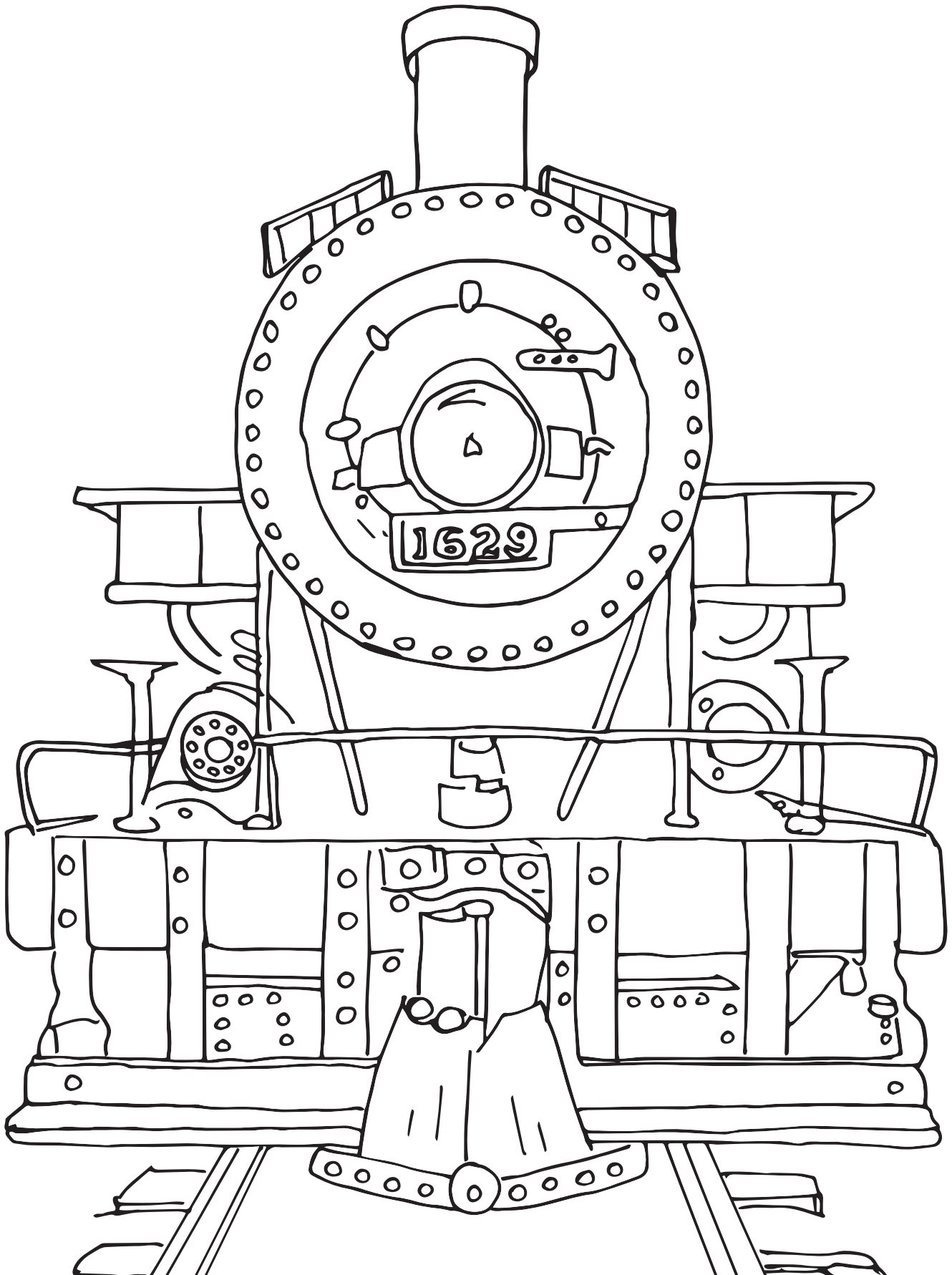

**MAIN STREET, MELODY RANCH MOTION PICTURE STUDIO
PLACERITA CANYON**

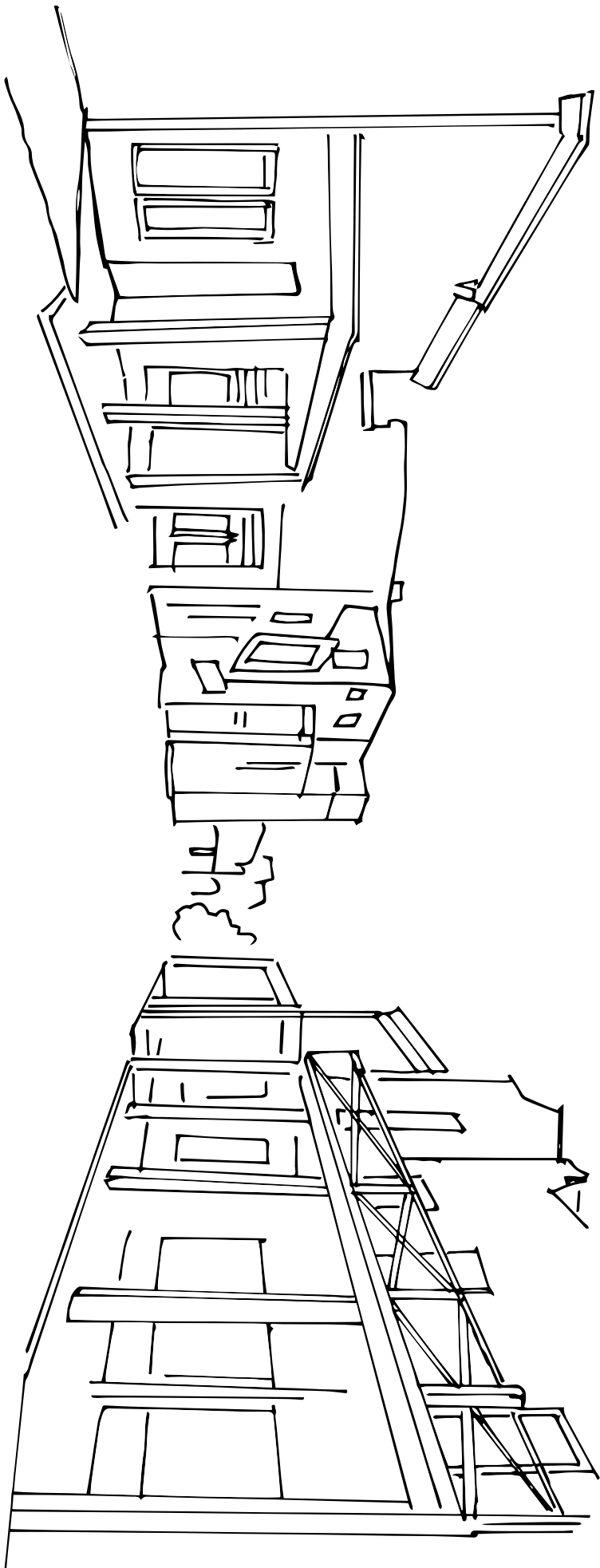

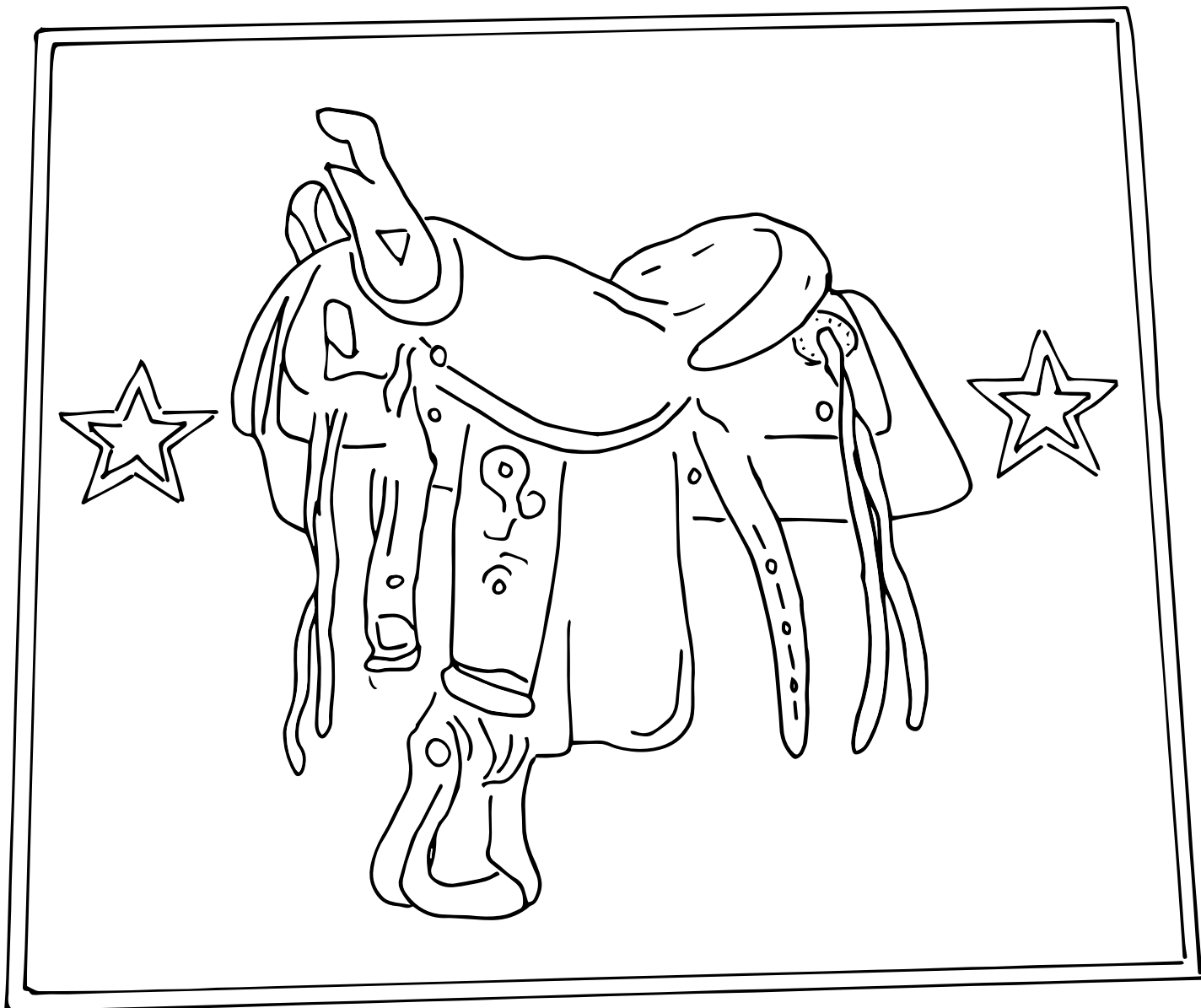

**WALK OF WESTERN STARS
OLD TOWN NEWHALL**

**WILLIAM S. HART
AND HIS HORSE, FRITZ
(SILENT FILM STAR)**

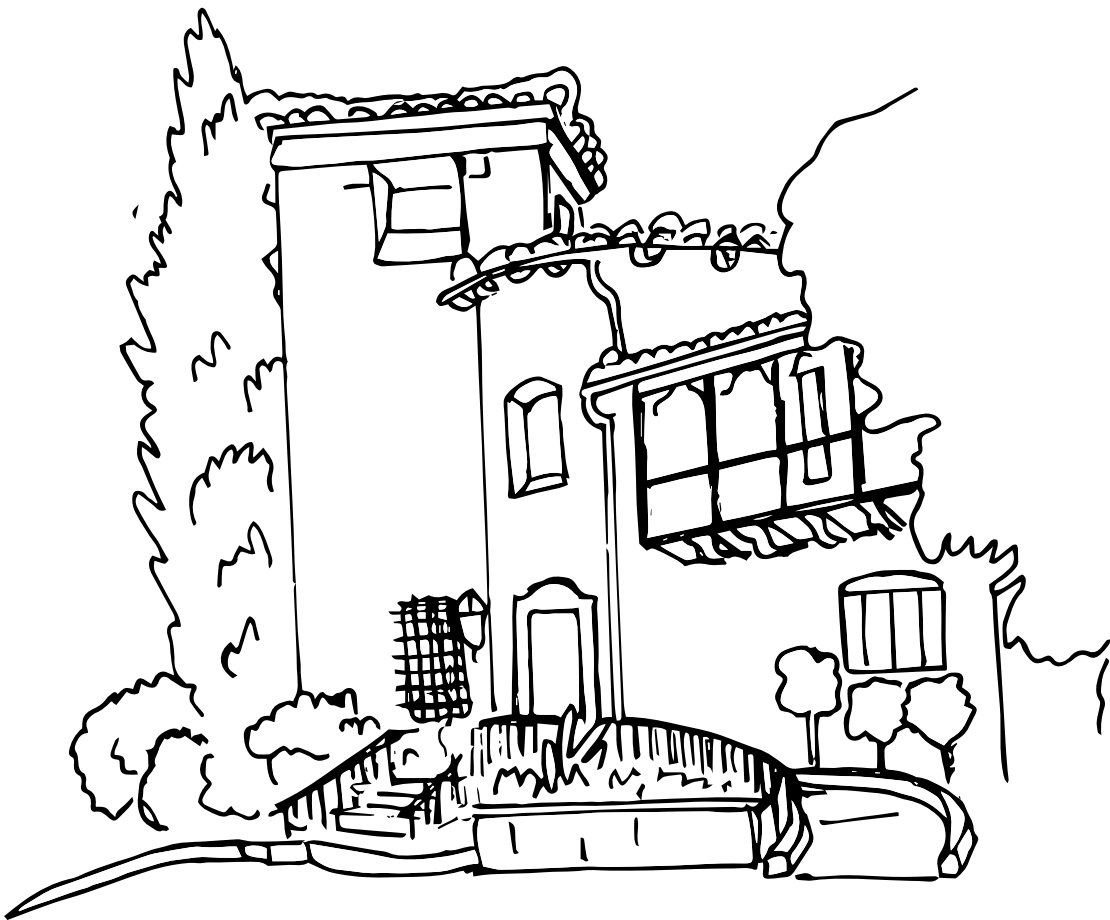

**LA LOMA DE LOS VIENTOS
WILLIAM S. HART MANSION
HART PARK**

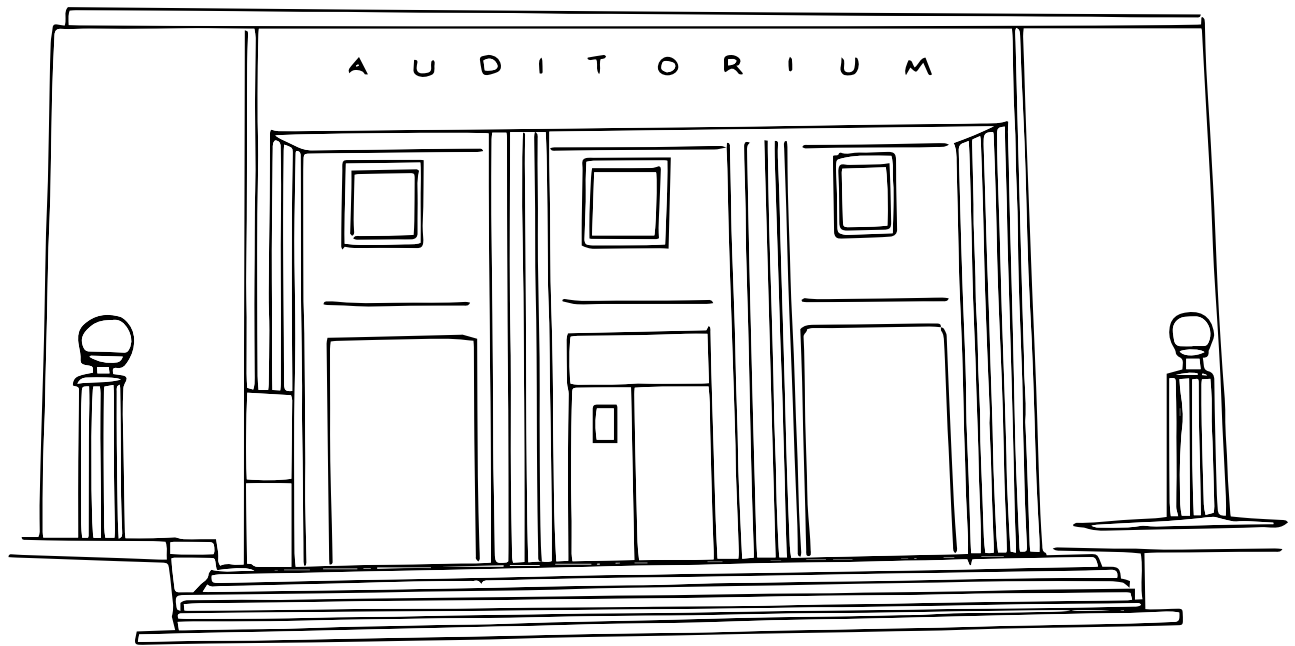

**NEWHALL SCHOOL AUDITORIUM
WALNUT STREET**

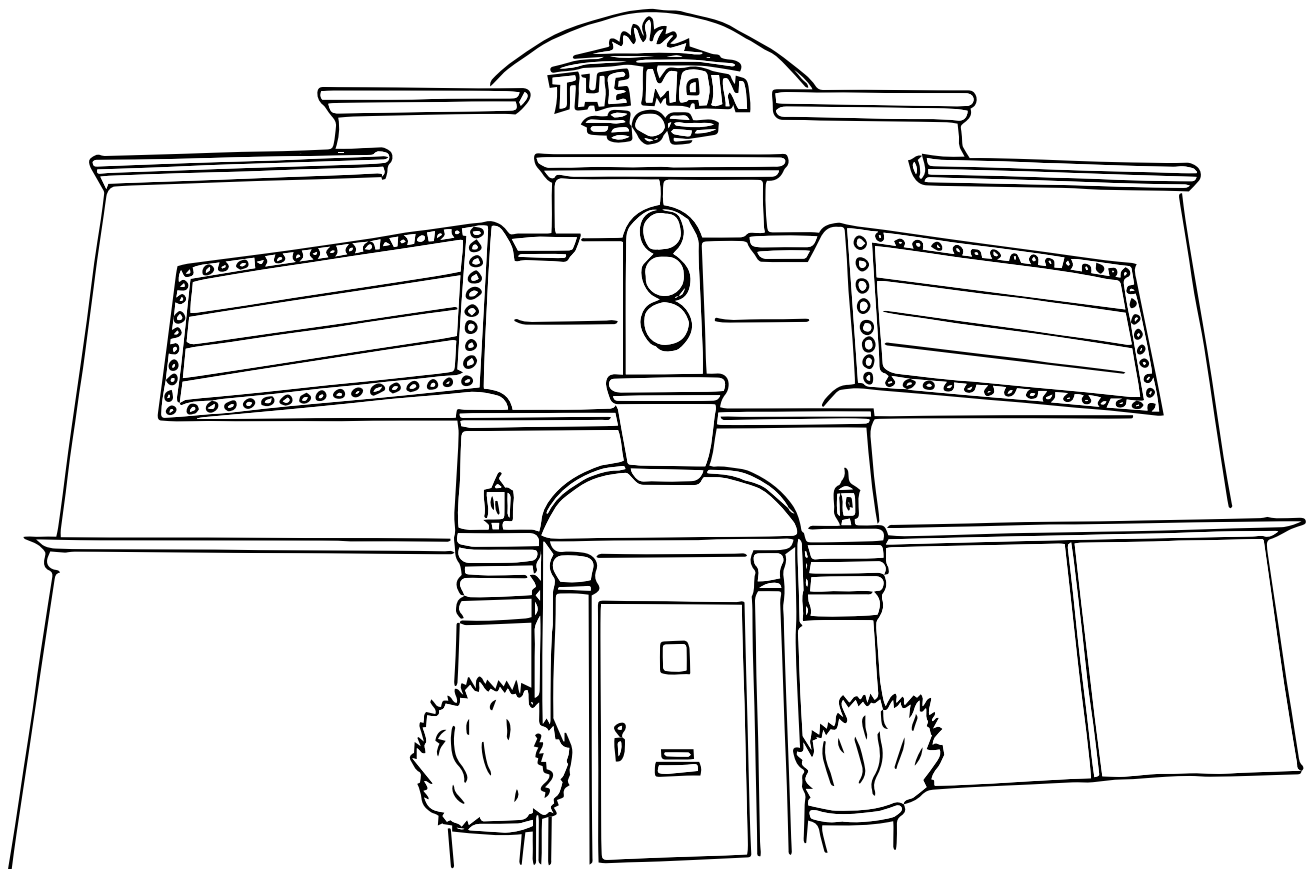

**THE MAIN
OLD TOWN NEWHALL**

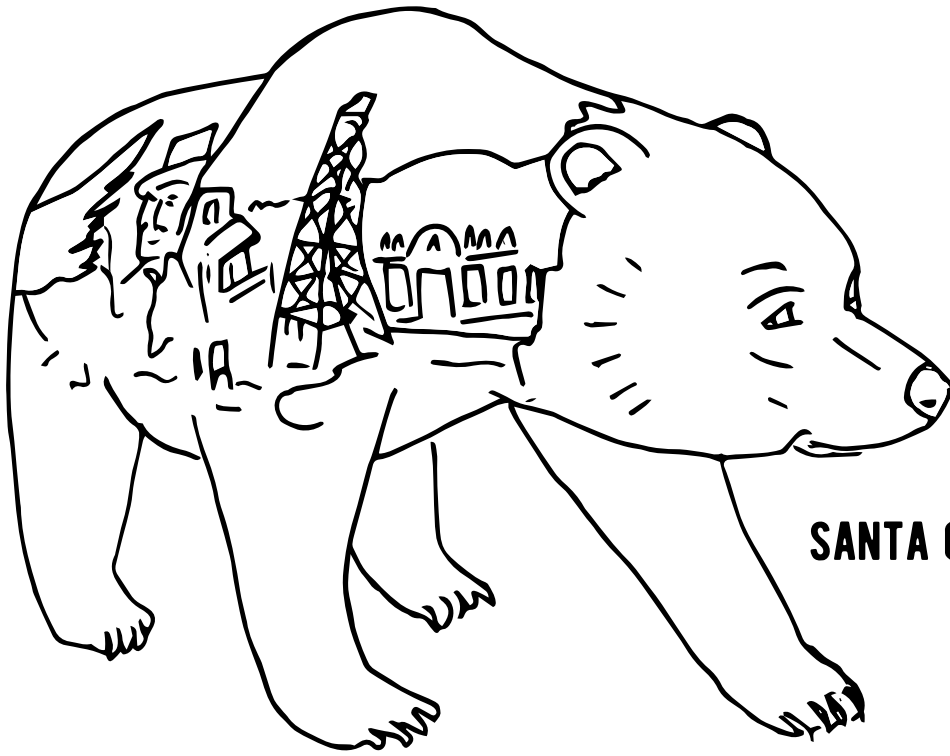

SANTA CLARITA HISTORY BEAR

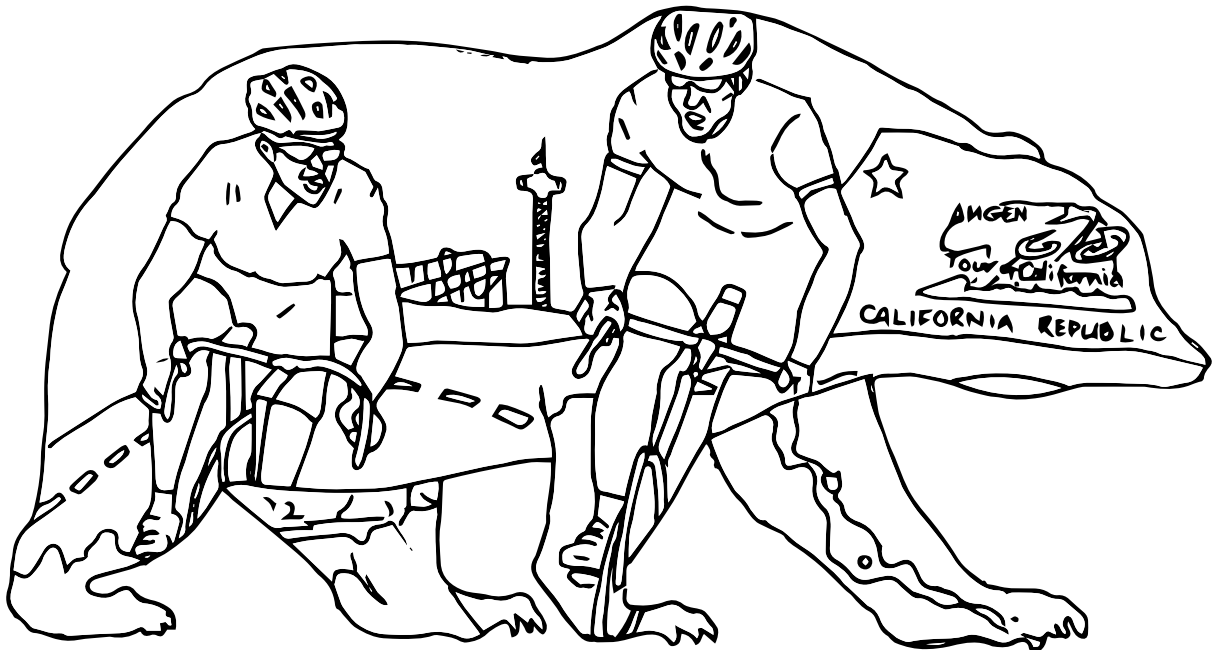

AMGEN CYCLING BEAR



WESTERN TIGER SWALLOWTAIL
CENTRAL PARK

THE FINAL LAP
SANTA CLARITA AQUATIC CENTER

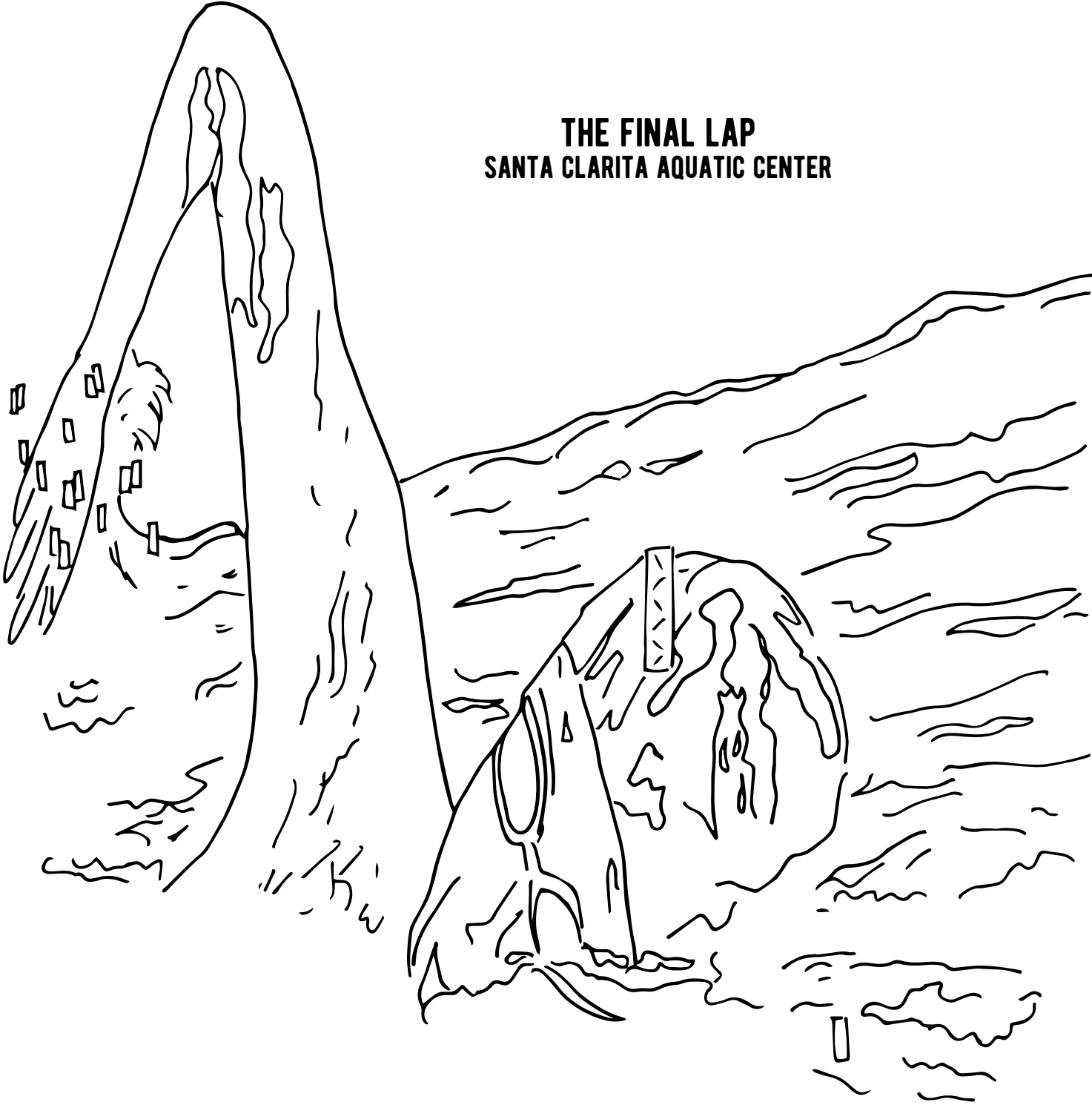

**FRIENDS
CANYON COUNTRY PARK**

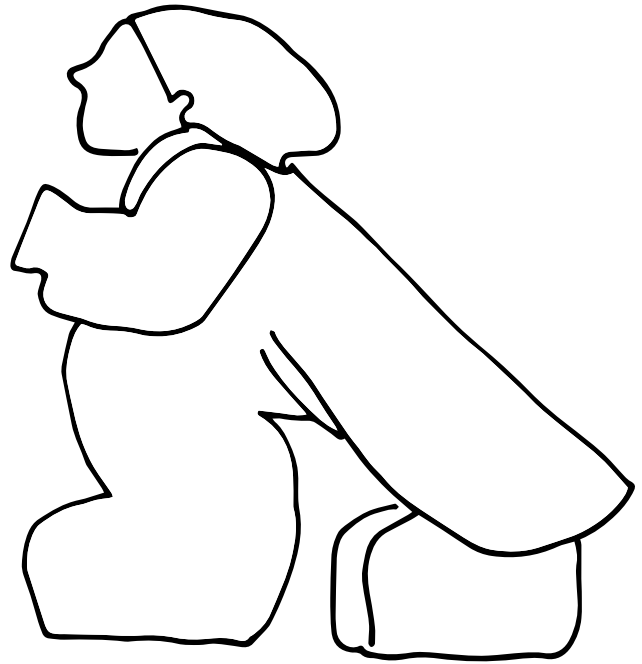
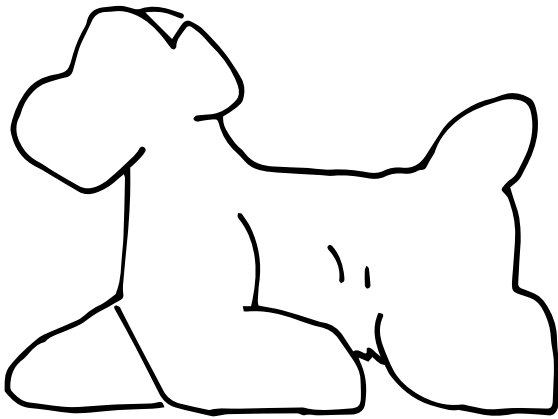

**LEARN MORE ABOUT SANTA CLARITA'S HISTORY
VISIT SCVHISTORY.COM**

**ART IS EVERYWHERE!
VISIT SANTACLARITAARTS.COM**

ANSWERS: CROSSWORD PUZZLE

Did you solve the mystery?!?!

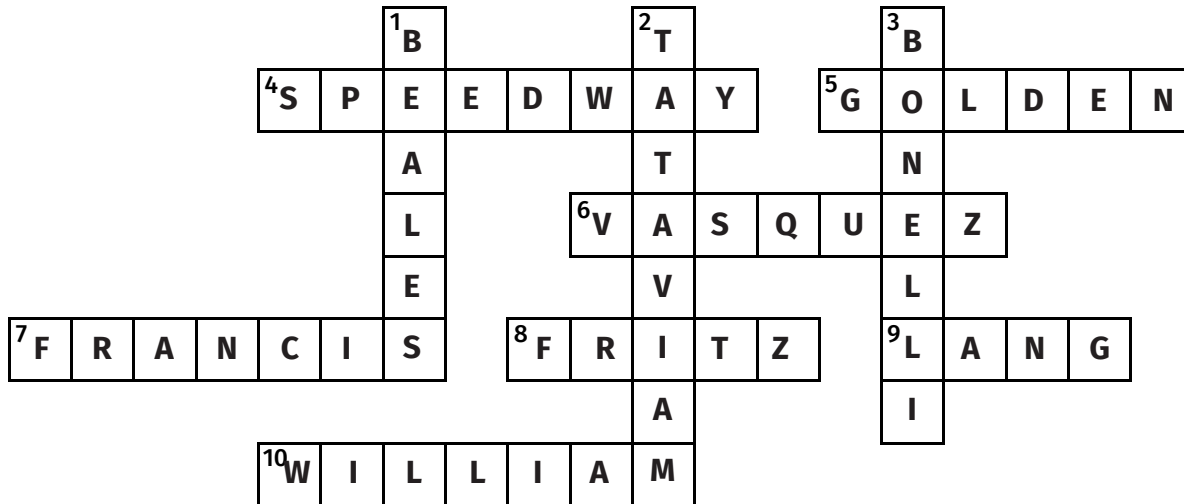

ACROSS

4. Car races were held at the Saugus _____.
5. Gold discovered at Oak of the _____ Dream
6. Bandit Tiburcio hid out at _____ Rocks.
7. Broke in 1928 - St. _____ Dam.
8. Bill Hart's horse's name
9. Golden spike hammered here bringing east/west tracks together at _____ Station.
10. Silent movie star _____ S. Hart

DOWN

1. Stagecoach mountain pass to Los Angeles: _____ Cut.
2. SCV Native American Tribe
3. Rodeos before car racing held here at _____ Stadium

ANSWERS: MATCH GAME

Check your knowledge!



1. History Bear



3. Crossroads



5. Friends

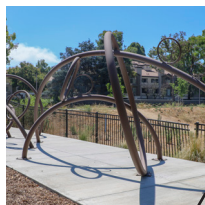

7. Archways



9. Western Walk of Stars saddles



2. Amgen Bicycle Bear



4. Art Tree Mural

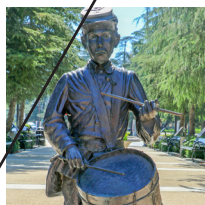

6. Willie Johnston



8. Western Tiger Swallowtail



10. Together in Fun and Fitness

A. McBean Transit Center

B. South Fork Trail

C. Newhall Community Center

D. Old Town Newhall Library

E. Bridge at Magic Mtn. Parkway

F. Chuck Pontius Commuter-Rail Trail

G. Old Town Newhall Library

H. Veterans Historical Plaza

I. Central Park

J. Canyon Country Park

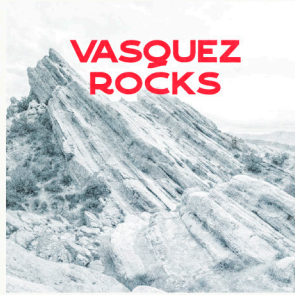

**VASQUEZ
ROCKS**



**CITY OF
GOLDEN
DREAMS**



**SOUTHERN
HOTEL**

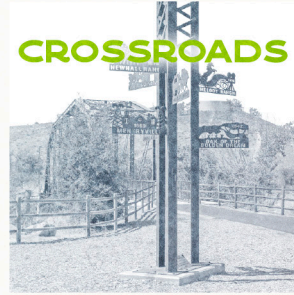

CROSSROADS



**CALIFORNIA
VAQUEROS**



**HART
MANSION**



**WILLIE
JOHNSTON**

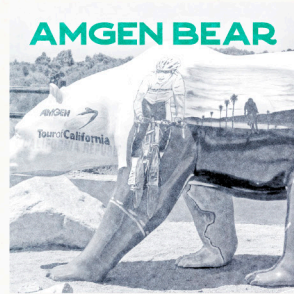

AMGEN BEAR

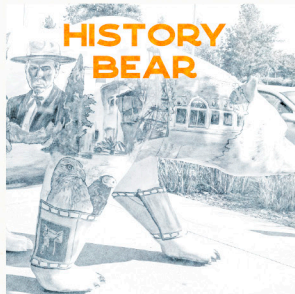

**HISTORY
BEAR**

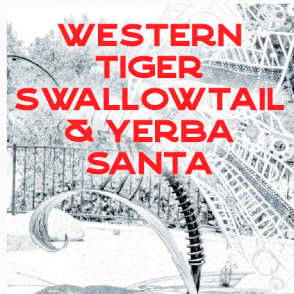

**WESTERN
TIGER
SWALLOWTAIL
& YERBA
SANTA**

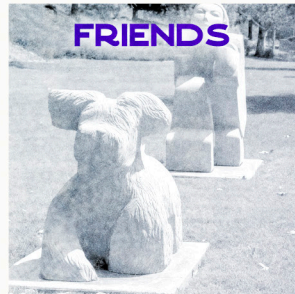

FRIENDS



**THE FINAL
LAP**

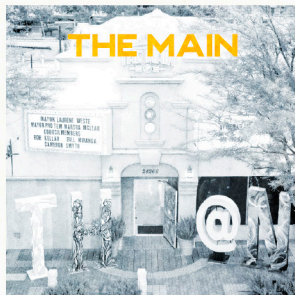

THE MAIN



**TOGETHER
IN FUN
AND FITNESS**

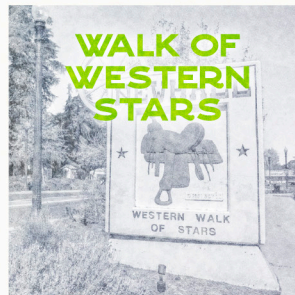

**WALK OF
WESTERN
STARS**

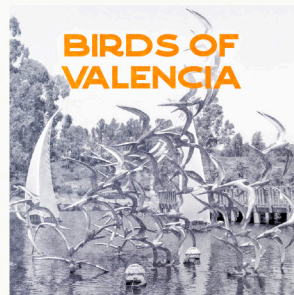

**BIRDS OF
VALENCIA**



City of
SANTA CLARITA

Founded December 15, 1987

santa-clarita.com